

Service Manual

Control Amplifier

Amplifier

System: SU-A900D

SU-C800U

SU-C800U

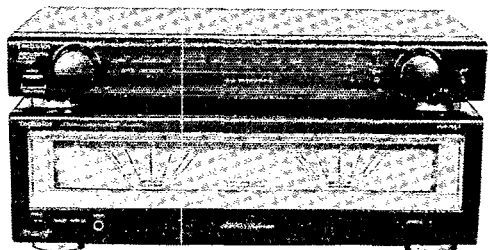

SE-A900S

Remote Control Transmitter

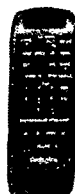

Colour

(K) : Black

Areas

Suffix for Model No.	Area	Colour
(E)	Europe, Asia, Latin America, Middle East, Africa and Oceania	(K)

System: SU-A800D

SU-C800U

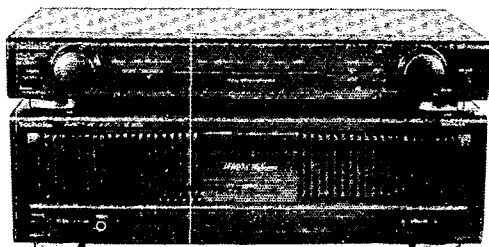

SE-A800S

Remote Control Transmitter



System: SU-A900D

Control amplifier	SU-C800U
Power amplifier	SE-A900S

System: SU-A800D

Control amplifier	SU-C800U
Power amplifier	SE-A800S

Because of unique interconnecting cables, when a component requires service, send or bring in the entire system.

Specifications (DIN 45 500)

Total harmonic distortion Vol. Max 20 Hz – 20 kHz 0.01 %

Input sensitivity/impedance

PHONO 2.5 mV/47 kΩ

TUNER, CD, AUX, TAPE 1, TAPE 2/DCC 200 mV/27 kΩ

Phono maximum input voltage (1 kHz, RMS) 150 mV

S/N

PHONO 76 dB (77 dB, IHF '66)

TUNER, CD, AUX, TAPE 1, TAPE 2/DCC 90 dB (97 dB, IHF '66)

Frequency response

PHONO RIAA standard curve ±1 dB (30 Hz – 15 kHz)

TUNER, CD, AUX, TAPE 1, TAPE 2/DCC

3 Hz – 80 kHz (+0, – 3 dB)
+0 dB, – 0.3 dB (20 Hz – 20 kHz)

Tone controls

BASS 50 Hz, +10 dB, –10 dB

TREBLE 20 kHz, +10 dB, –10 dB

Output voltage

TAPE 1, TAPE 2/DCC REC OUT 200 mV

PRE OUT 1 V

Channel balance (AUX, 250 Hz – 6.3 kHz) ±1 dB

Channel separation (AUX, 1 kHz) 50 dB

■ GENERAL

Dimensions (W × H × D) 430 × 69.3 × 307 mm

Weight 2.7 kg

Notes:

- Design and specifications are subject to change without notice. Weight and dimensions are approximate.
- Total harmonic distortion is measured by the digital spectrum analyzer.

⚠ WARNING

This service information is designed for experienced repair technicians only and is not designed for use by the general public. It does not contain warnings or cautions to advise non-technical individuals of potential dangers in attempting to service a product. Products powered by electricity should be serviced or repaired only by experienced professional technicians. Any attempt to service or repair the product or products dealt with in this service information by anyone else could result in serious injury or death.

Technics®

© 1995 Matsushita Electric Industrial Co., Ltd.
All rights reserved. Unauthorized copying and distribution is a violation of law.

Contents

	Page		Page
Front Panel Controls	2	Printed Circuit Board Diagram	10~12
Operation Check and Main Component Replacement Procedures	3	Wiring Connection Diagram	12
To Supply Power Source	4	Block Diagram	13
Function of IC Terminals	5	Replacement Parts List	14~17
Schematic Diagram	5~9	Cabinet Parts Location	16

NOTE:

Refer to the service manual for Model No. SE-A900S (ORDER No. AD9506164C8) or SE-A800S (ORDER No. AD9506165C2) for information on "Accessories", "Connections", "Operations" and "Packaging".

Front Panel Controls

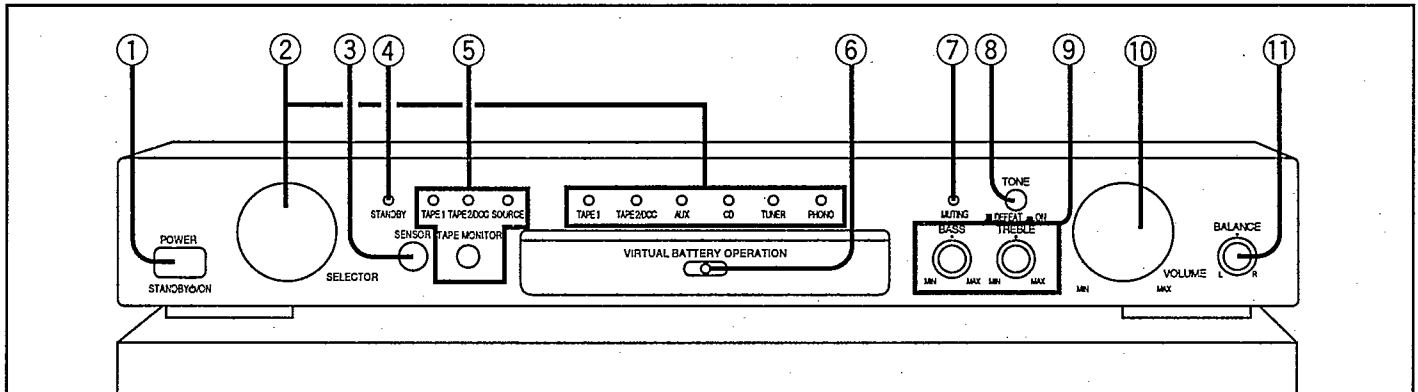

① Power "STANDBY" switch

(POWER, STANDBY / ON)

Press to switch the unit from on to standby mode or vice versa. In standby mode, the unit is still consuming a small amount of power.

If the power amplifier is turned on while the control amplifier is on, this switch can then be used to turn both amplifiers on or to standby mode simultaneously.

② Input selector/indicators (SELECTOR)

③ Remote control signal sensor (SENSOR)

④ "STANDBY" indicator (STANDBY)

When the unit is connected to the AC mains supply, this indicator lights up in standby mode and goes out when the unit is turned on.

⑤ Tape-monitor button/indicators (TAPE MONITOR)

⑥ "VIRTUAL BATTERY OPERATION" indicator

This will illuminate to indicate that the virtual battery (a circuit which removes the noise contained in the power supply while playing a sound input source) is functioning.

⑦ Muting indicator (MUTING)

⑧ Tone control button (TONE)

⑨ Tone controls (BASS, TREBLE)

⑩ Volume control (VOLUME)

⑪ Balance control (BALANCE)

Operation Check and Main Component Replacement Procedures

- NOTE**
1. This section describes procedures for checking the operation of the major printed circuit boards and replacing the main components.
 2. For reassembly after operation checks or replacement, reverse the respective procedures. Special reassembly procedures are described only when required.
 3. Illustrated screws are equivalent to actual size.

1. Checking for the operation P.C.B. and main P.C.B.

-
- a** (Black) [RHD30035-K1]
 - b, c** (Black) [XTBS3+8JFZ1]
 - d** (Black) [XTB3+20JFZ]

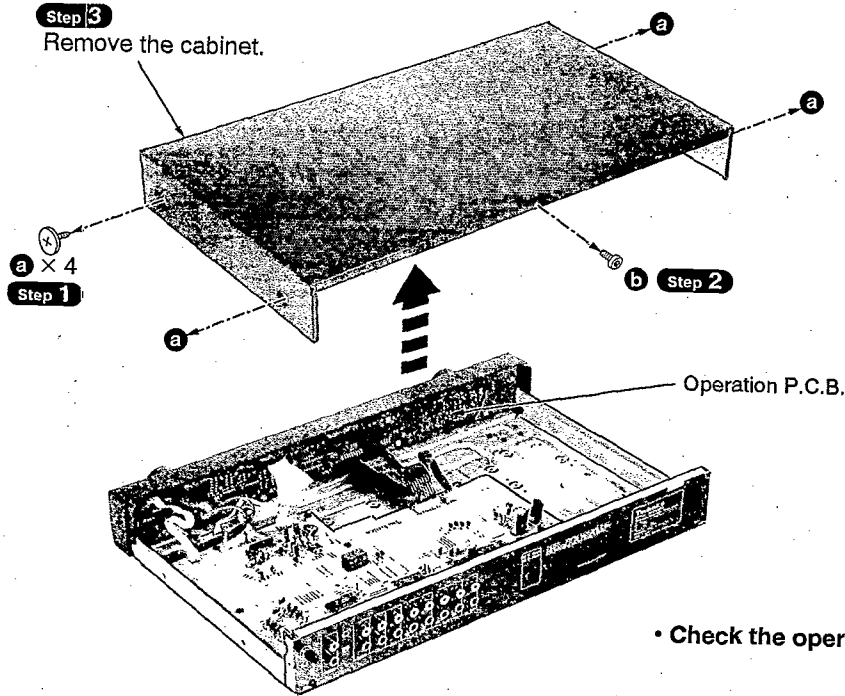

• Check the operation P.C.B. this condition.

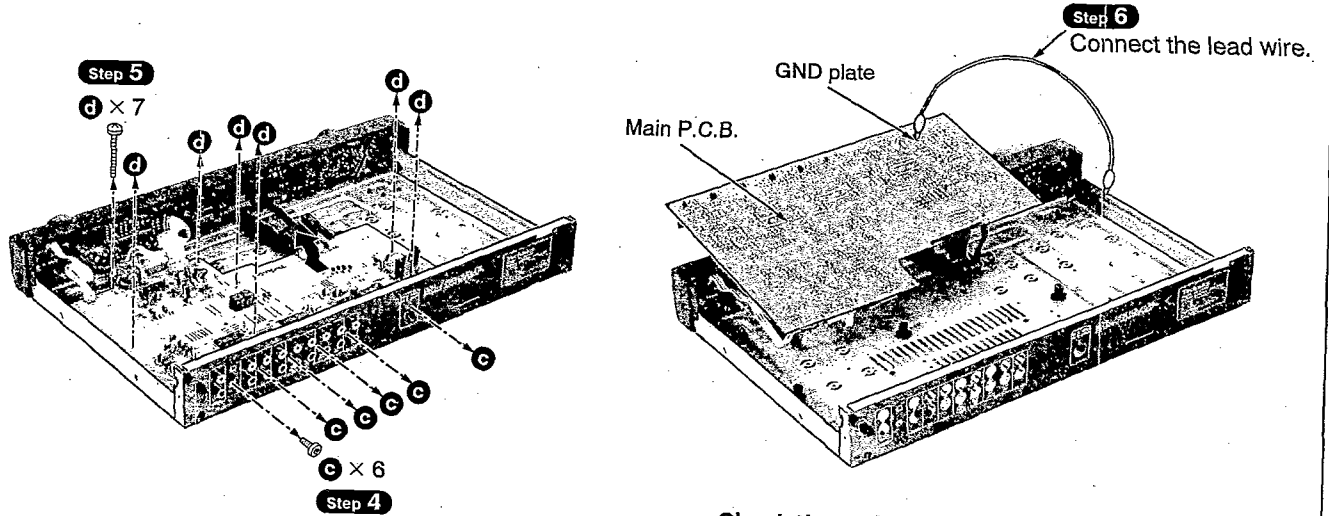

• Check the main P.C.B. as shown above.

■ To Supply Power Source

This unit SU-C800U is designed to operate on power supplied from the Power Amplifier SE-A900S or SE-A800S. When operating the unit SU-C800U alone for testing and servicing, without having power supplied from the Power Amplifier SE-A900S or SE-A800S, use the following method.

Power Supply to Main Circuit

1. Apply 11 V AC power to the section between the point **TP1** and the point **TP2**.
2. Connect the DC +12 V to +15 V (more than 0.1 A) to the point **TP5**, and the GND terminal to the point **TP4** using the DC power supply.
2. Connect the DC -12 V to -15 V (more than 0.1 A) to the point **TP3**, and the GND terminal to the point **TP4** using the DC power supply.

Operation Check

1. Input a signal (1 kHz, 100 mV) to the each line-in terminal.
3. Connect the oscilloscope or the speaker with the built-in amplifier to the PRE OUT terminals and check if the signals are outputting from this unit.

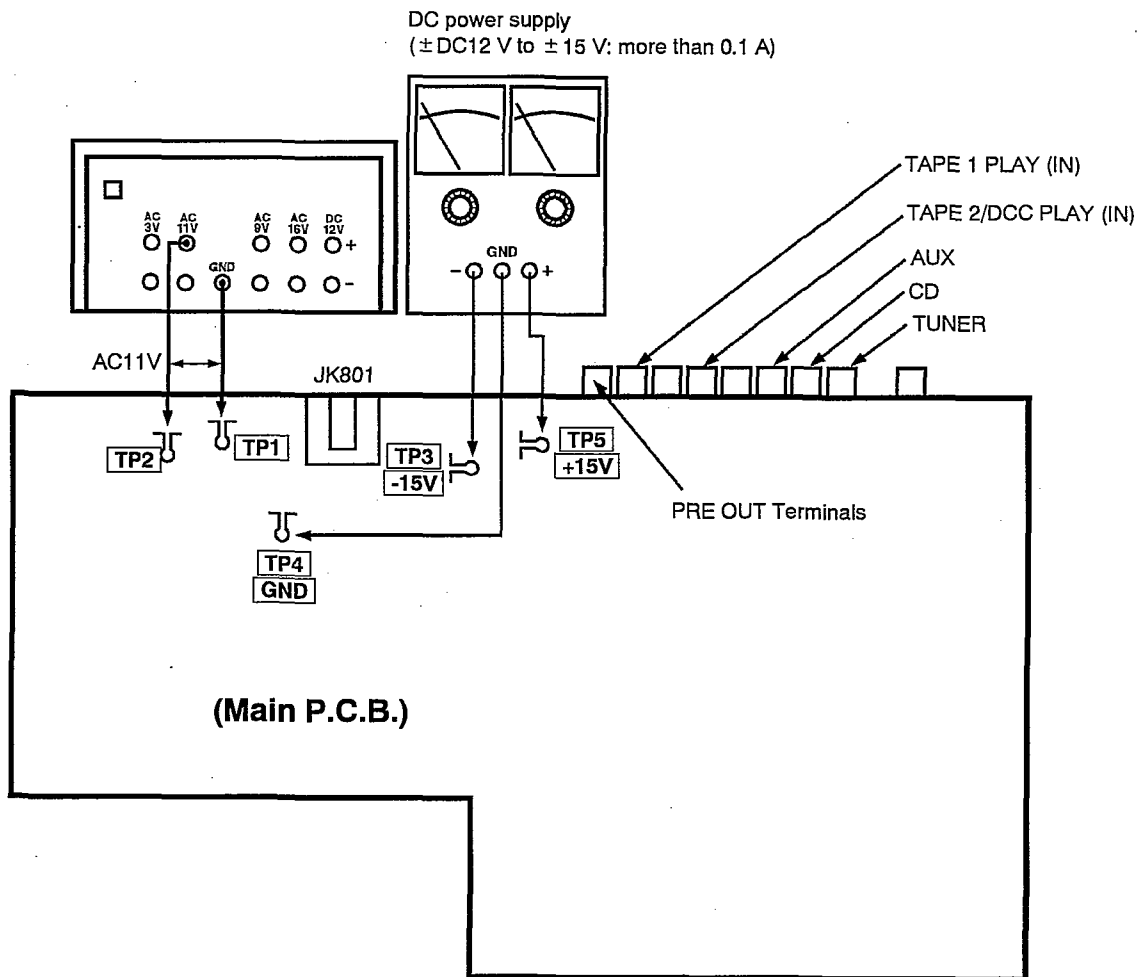

Fig. 1

■ Function of IC Terminals

● IC701 (M37470M2332S)

Pin No.	Terminal Name	I/O	Function
1	SDATA	O	Data signal output for input select IC (IC201 and IC202)
2	CLOCK	O	Clock signal output for input select IC (IC201 and IC202)
3	STB	O	Strobe signal output for input select IC (IC201 and IC202)
4	SELLED2	O	Input select LED drive signal output
5	SELLED1		
6	SELLED0		
7	VRDOWN	O	Motor drive signal output (Volume down)
8	VRUP	O	Motor drive signal output (Volume up)
9	ASWMUTE	O	Audio signal muting signal output
10	BATLVL1	I	Not used, connect to GND
11	KEYAD	I	Power switch and Tape monitor switch signal
12	RSWAD	I	Input selector switch (S804) signal input
13	VREF	I	Reference voltage input
14	XIN	I	Connect to the ceramic oscillator
15	XOUT	O	
16	GND	—	Connect to GND

Pin No.	Terminal Name	I/O	Function
17	VCC	I	Power supply (+5V)
18	RESET	I	System reset signal input
19	BACKUP	I	Power failure detect signal input
20	REMCON	I	Remote control signal input
21	BATLVL2	I	Not used, connect to GND
22	CS	I	Chip select signal input (Connect to GND)
23	MUTLED	O	Muting LED (D711) drive signal output
24	SRCELED	O	Source LED (D810) drive signal output
25	TP2MLED	O	Tape 2 LED (D811) drive signal output
26	TP1MLED	O	Tape 1 LED (D812) drive signal output
27	BATFLED	O	Not used, connect to GND
28	BATELED		
29	BATRLY		
30	CHGRRLY		
31	OPTRLY	O	Relay drive signal output
32	PWRRLY	O	Power control signal output

■ Schematic Diagram

	Page
A MAIN CIRCUIT	6~9
B TONE SWITCH CIRCUIT	7, 8
C VOLUME CIRCUIT	7
D BALANCE VR CIRCUIT	7
E POWER SWITCH CIRCUIT	7
F OPERATION CIRCUIT	7, 8





● This schematic diagram may be modified at any time with the development of new technology.

Notes:

- S301 : Tone control switch (TONE ■:DEFEAT, ■:ON)
- S801 : Power "STANDBY ϕ /ON" switch (POWER, STANDBY ϕ /ON)
- S802 : Tape monitor switch (TAPE MONITOR)
- S804 : Input select switch (SELECTOR)
- VR201 : Volume control VR (VOLUME)
- VR202 : Balance control VR (BALANCE)
- VR301 : Tone control VR (BASS)
- VR302 : Tone control VR (TREBLE)

- Indicated voltage values are the standard values for the unit measured by the DC electronic circuit tester (high-impedance) with the chassis taken as standard. Therefore, there may exist some errors in the voltage values, depending on the internal impedance of the DC circuit tester.
No mark: Power ON

● Voltage and signal line

-  : Phono Signal (L-ch) Line
-  : Rec Out Signal (L-ch) Line
-  : Positive Voltage Line
-  : Negative Voltage Line

● Important safety notice:

Components identified by Δ mark have special characteristics important for safety. Furthermore, special parts which have purposes of fire-retardant (resistors), high-quality sound (capacitors), low-noise (resistors), etc. are used. When replacing any of components, be sure to use only manufacturer's specified parts shown in the parts list.

● Caution!

IC and LSI are sensitive to static electricity. Secondary trouble can be prevented by taking care during repair. Cover the parts boxes made of plastics with aluminum foil. Ground the soldering iron. Put a conductive mat on the work table. Do not touch the legs of IC or LSI with the fingers directly.

A MAIN CIRCUIT
(P.C.Board: on page 11)

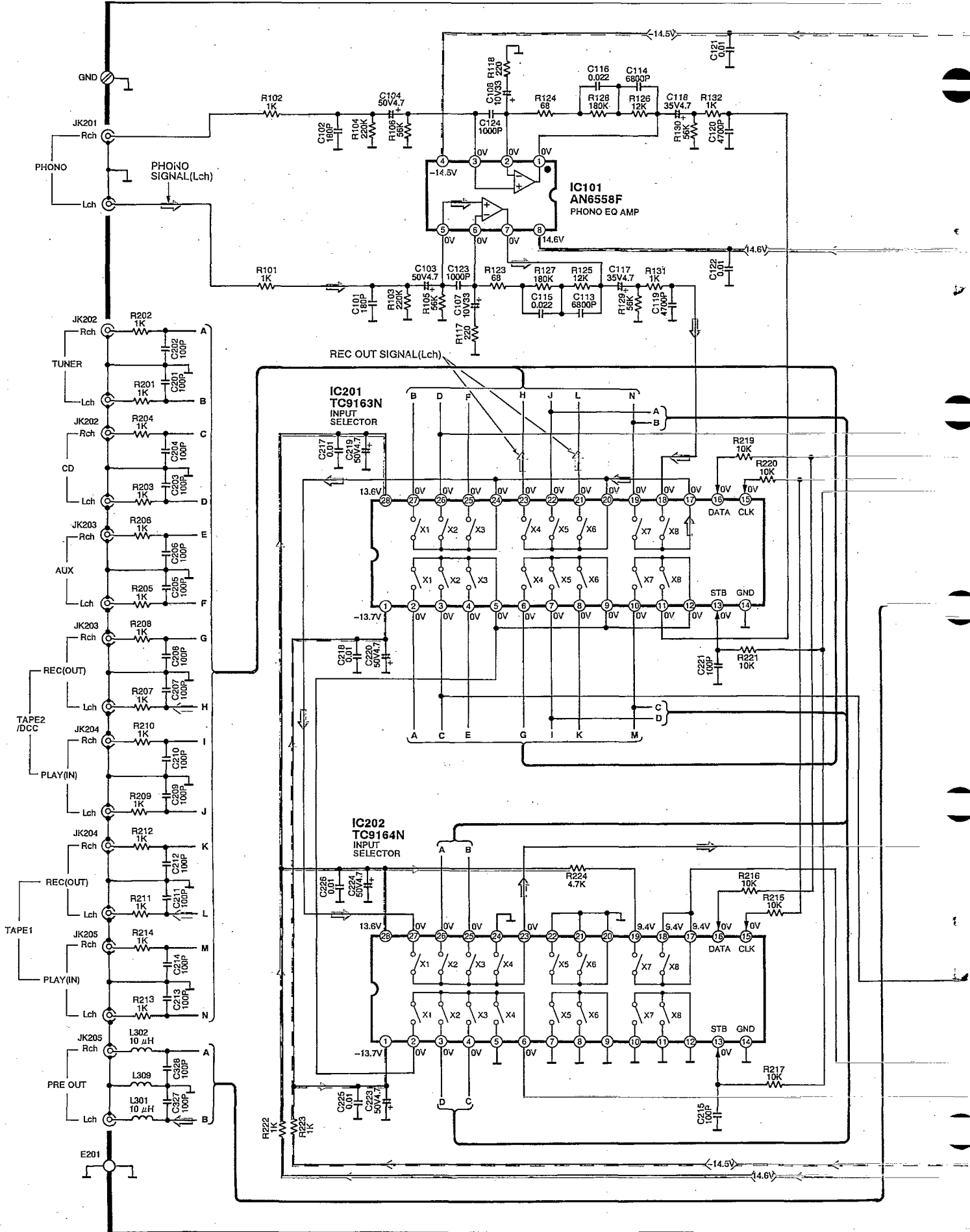

→ : Phono Signal (L-ch) Line
→ : Positive Voltage Line

→ : Rec Out Signal (L-ch) Line
- - - - : Negative Voltage Line

B TONE SWITCH CIRCUIT
(P.C. Board: on page 10)

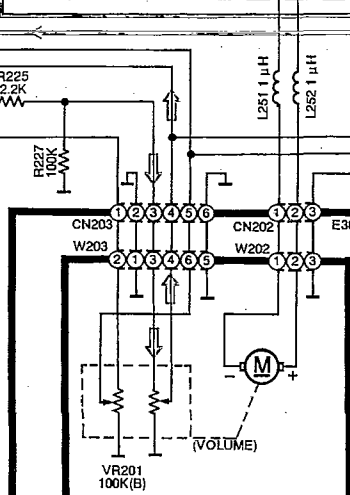
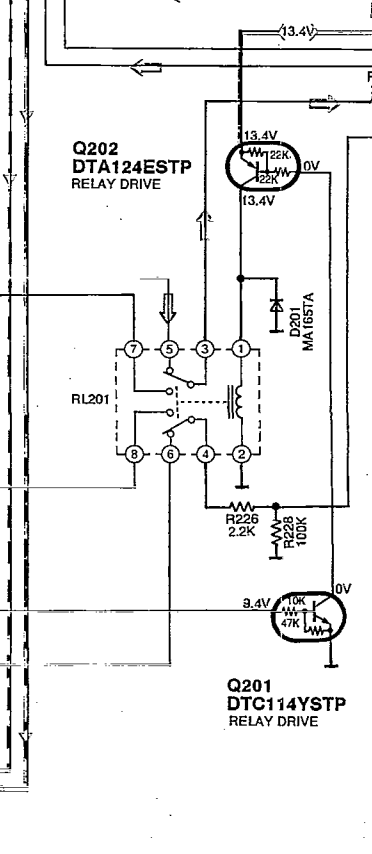
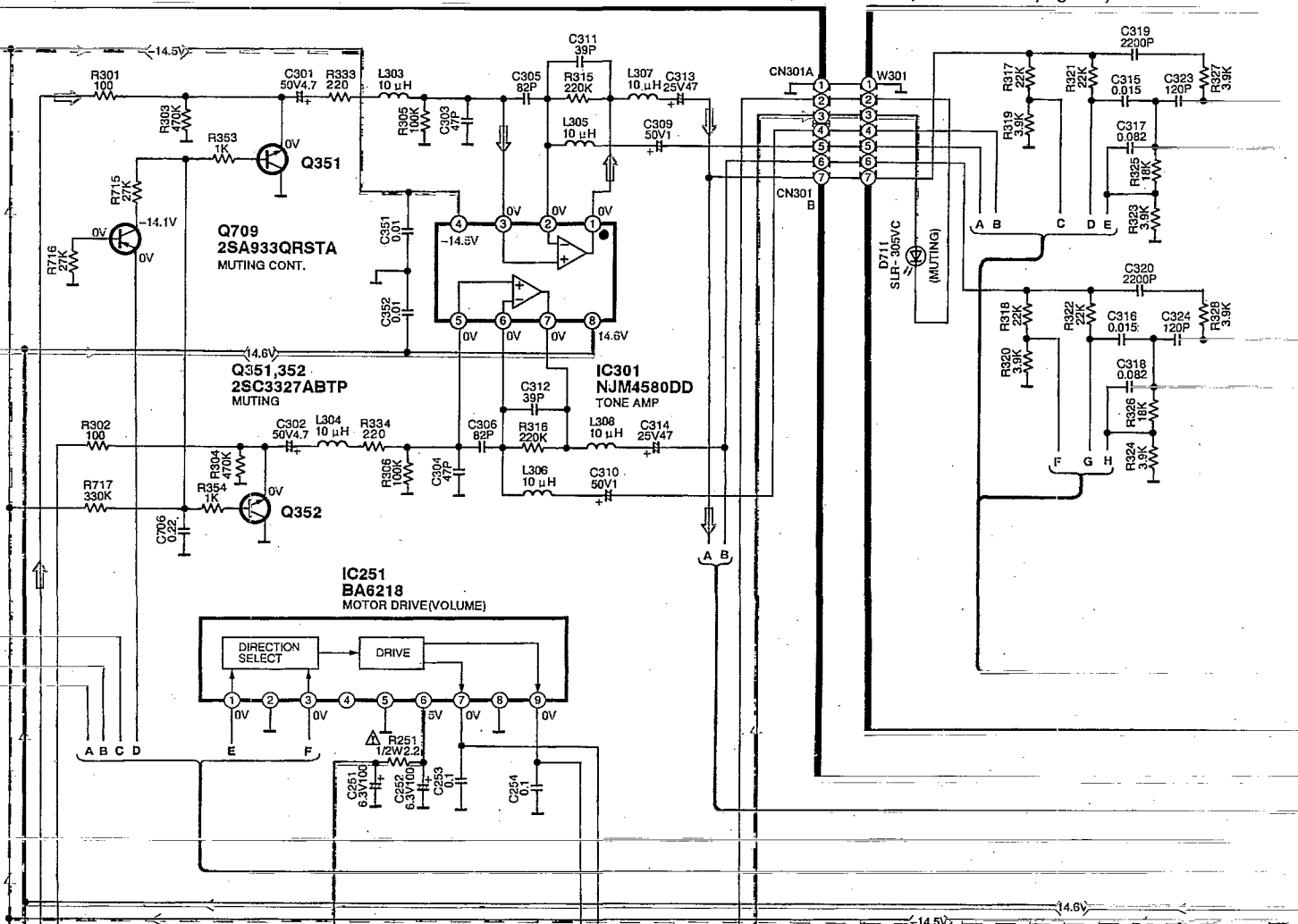

C VOLUME CIRCUIT
(P.C. Board: on page 10)

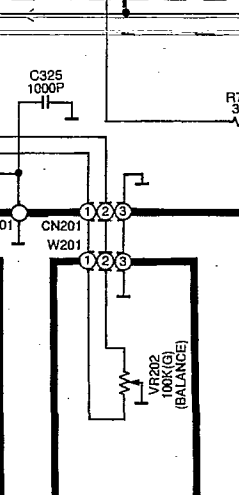

D BALANCE VR CIRCUIT
(P.C. Board: on page 10)

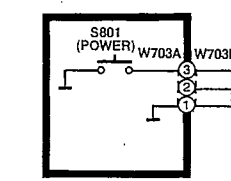



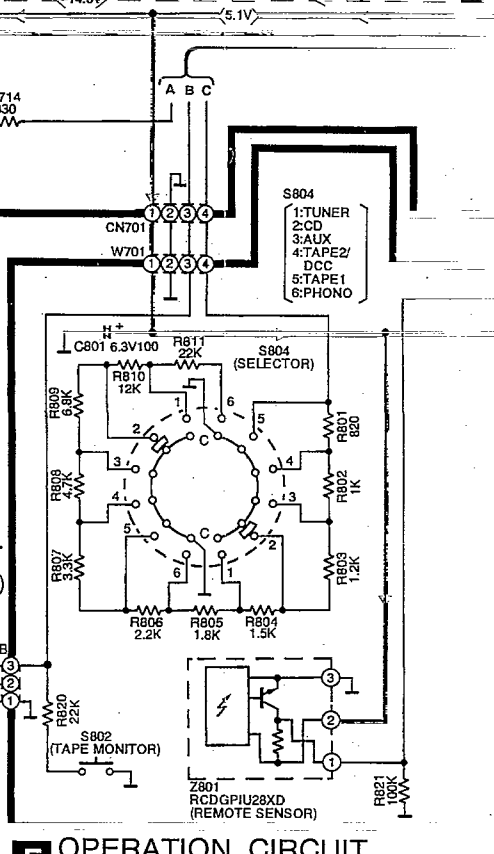

E POWER SWITCH CIRCUIT
(P.C. Board: on page 10)

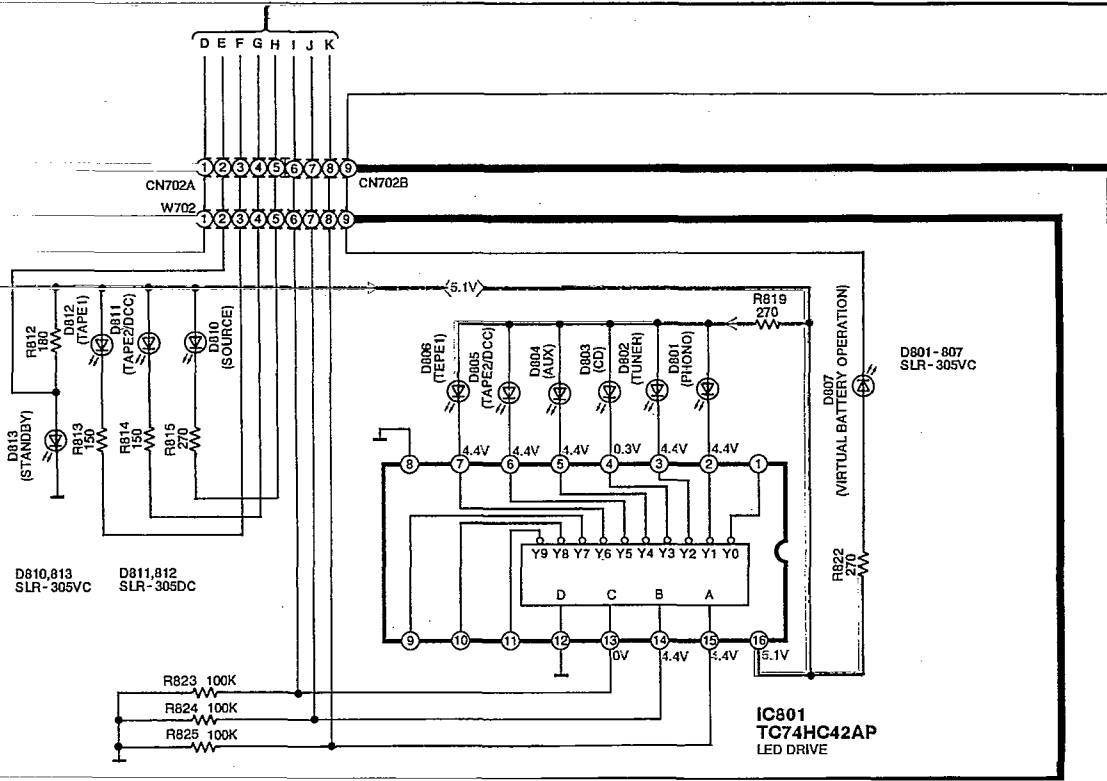
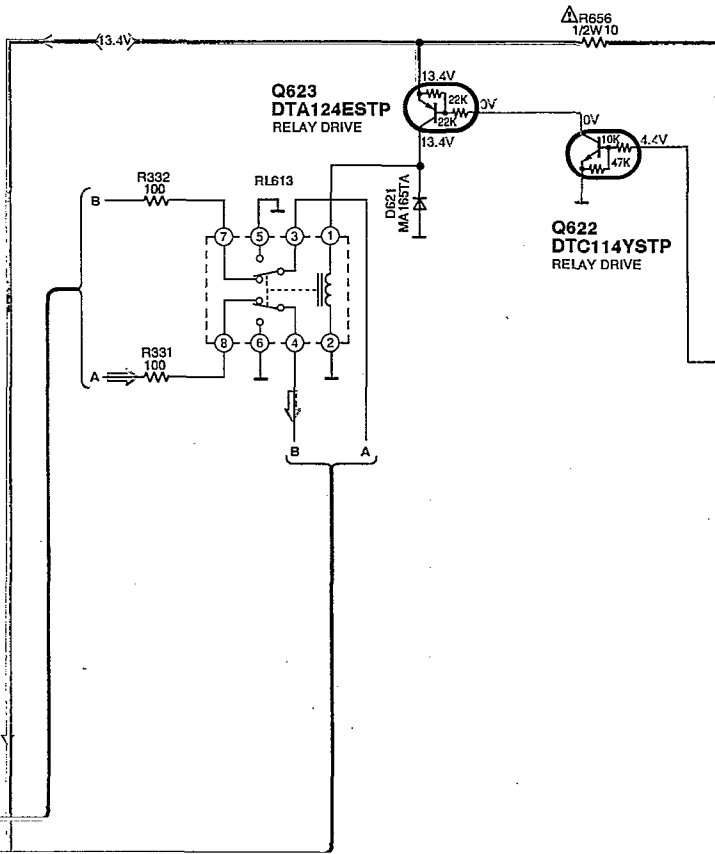
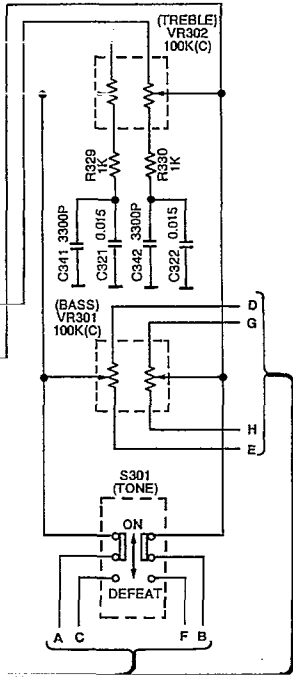

F OPERATION CIRCUIT
(P.C. Board: on page 10)

A MAIN CIRCUIT
(P.C.Board: on page 11)



 : Phono Signal (L-ch) Line
 : Rec Out Signal (L-ch) Line
 : Positive Voltage Line
 : Negative Voltage Line

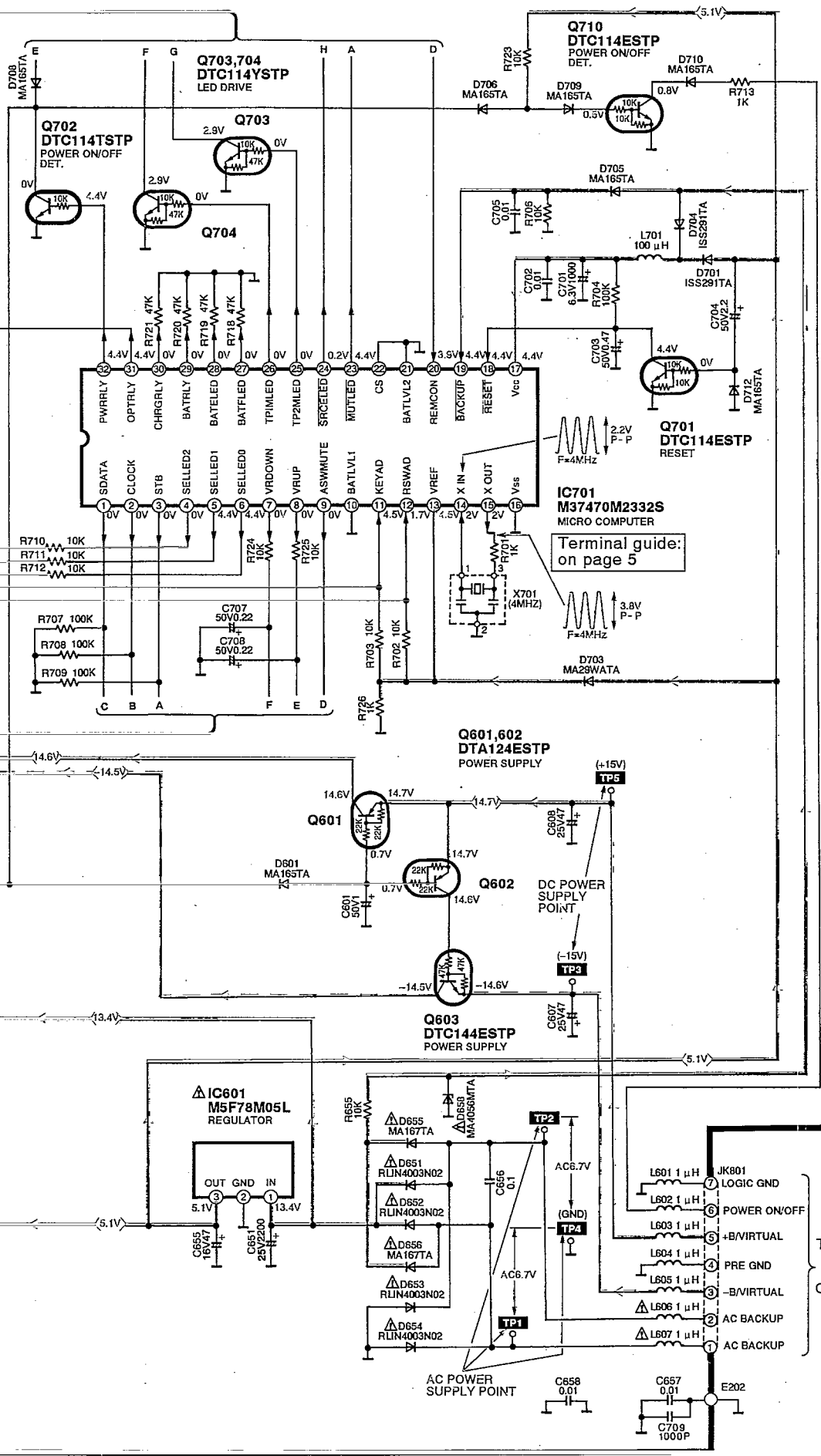

Terminal guide:
on page 5

TO SE-A800S:
 JK791
 (on page 18)
 OR SE-A800S:
 JK791
 (on page 17)

Printed Circuit Board Diagram

• This circuit board diagram may be modified at any time with the development of new technology.

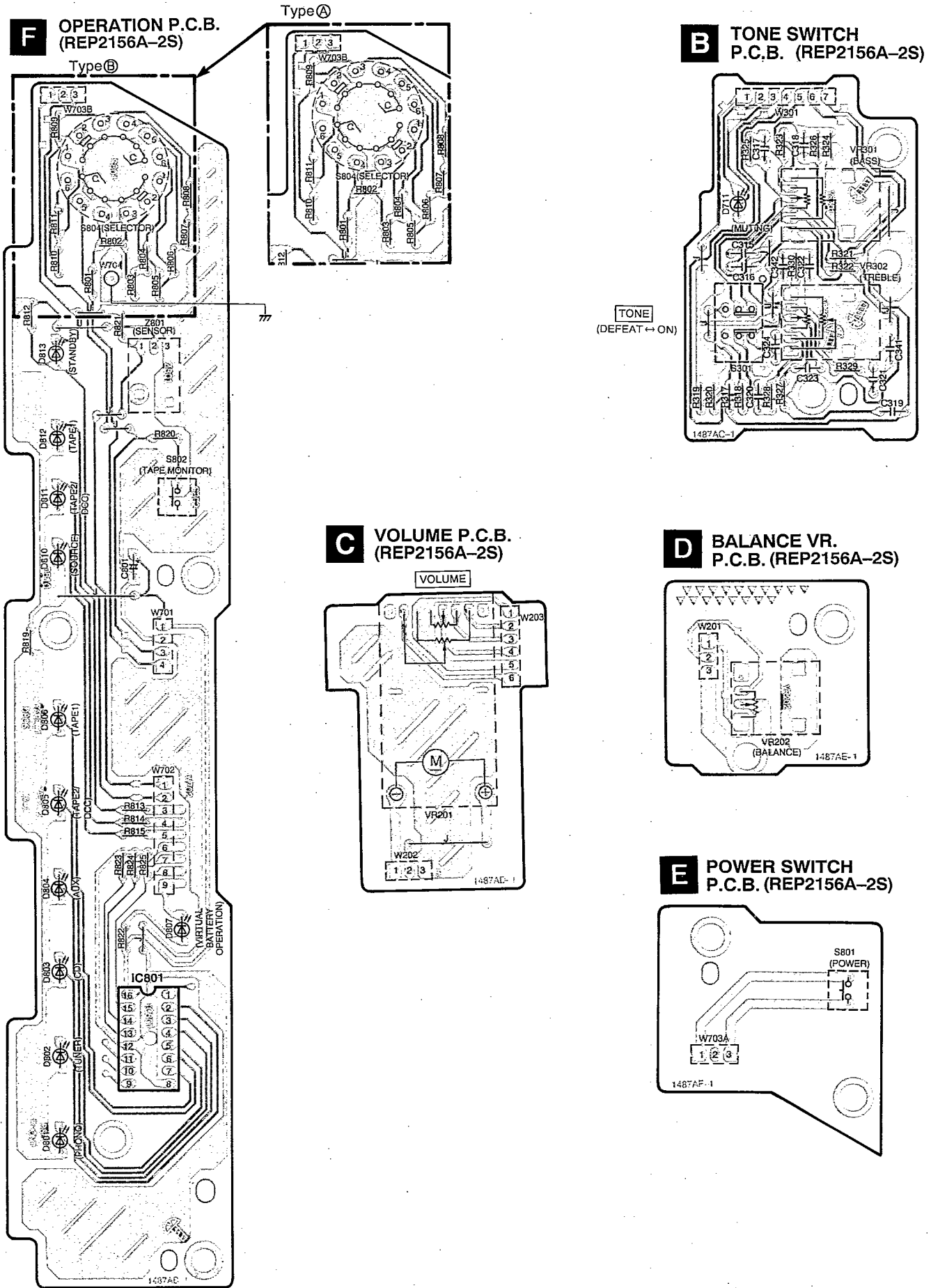

F OPERATION P.C.B. (REP2156A-2S)

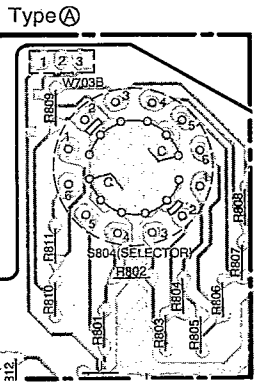

B TONE SWITCH P.C.B. (REP2156A-2S)

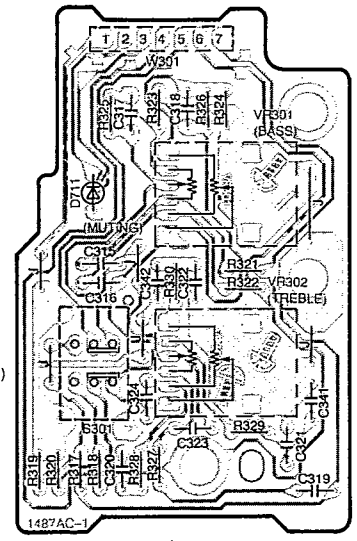

C VOLUME P.C.B. (REP2156A-2S)

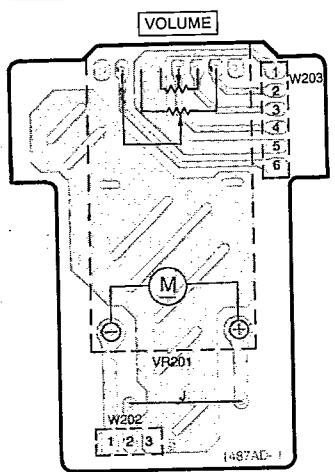

D BALANCE VR. P.C.B. (REP2156A-2S)

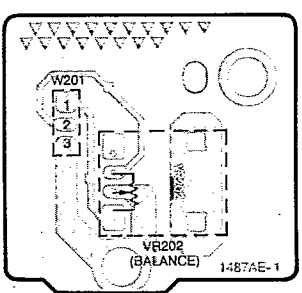

E POWER SWITCH P.C.B. (REP2156A-2S)

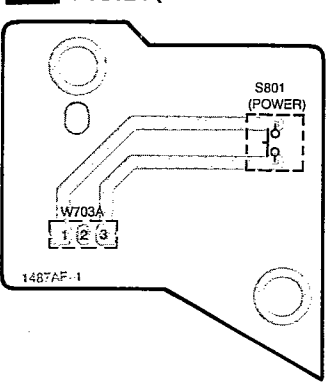

A MAIN P.C.B. (REP2156A-1S) [There are two kinds of Type(A),(B)in the Main P.C.B.]

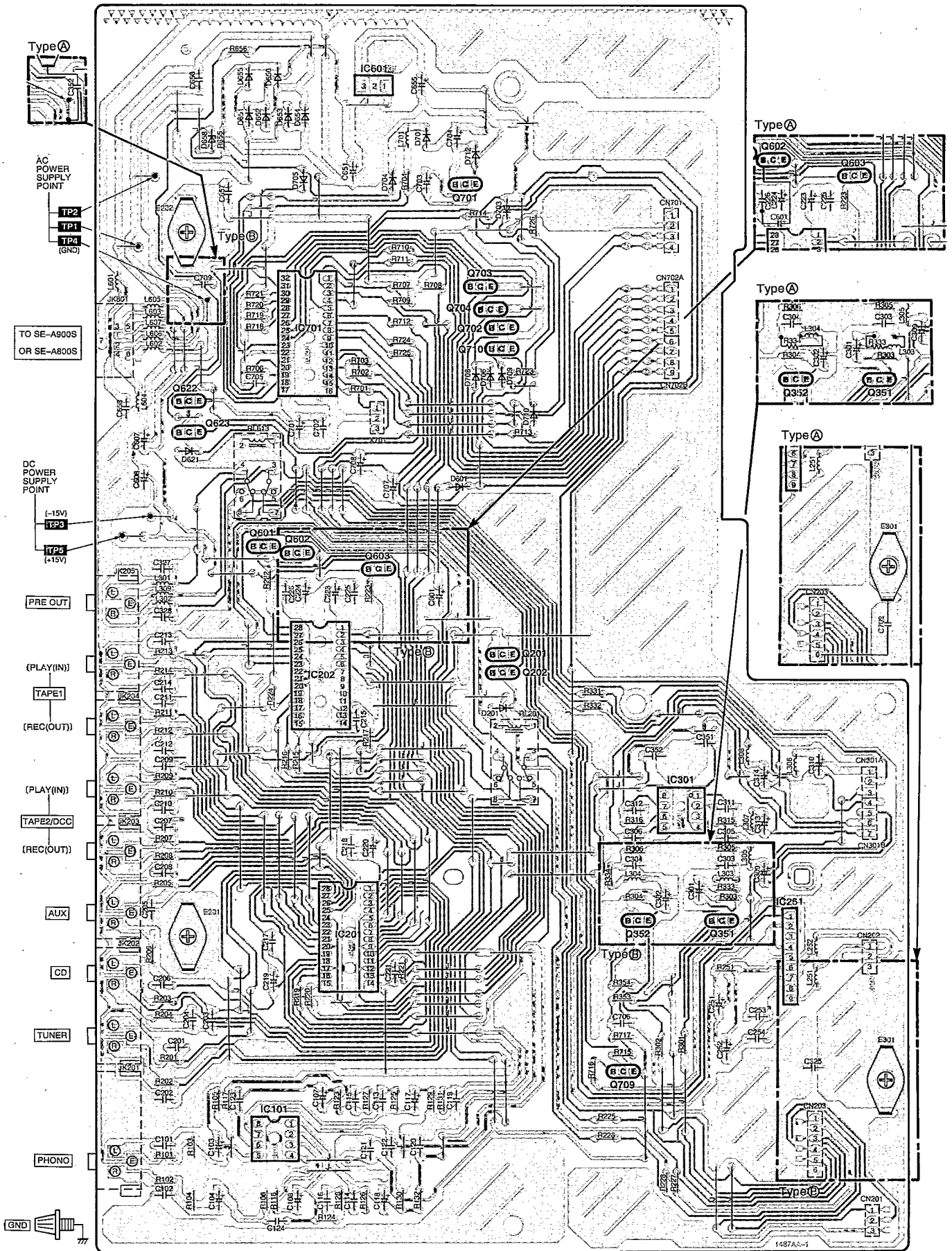

Notes:
 Type (B) is different from Type (A) in part of the foil patterns and the parts.
 Repair the unit with attention to the differences.

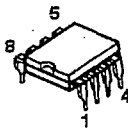
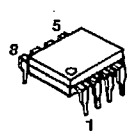
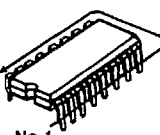
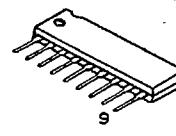
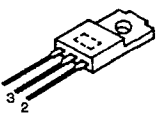
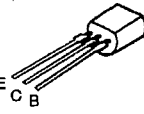
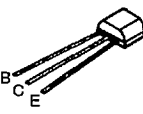
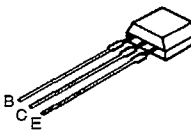
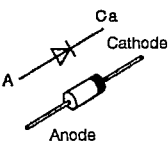
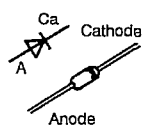
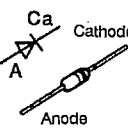
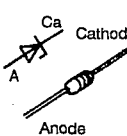
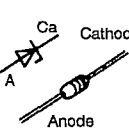
<p>AN6558F</p> 	<p>NJM4580DD</p> 	 <table border="1" data-bbox="710 112 949 268"> <tr> <td>TC74HC42AP</td> <td>16Pin</td> </tr> <tr> <td>TC9163N</td> <td>28Pin</td> </tr> <tr> <td>TC9164N</td> <td>28Pin</td> </tr> <tr> <td>M37470M2332S</td> <td>32Pin</td> </tr> </table>	TC74HC42AP	16Pin	TC9163N	28Pin	TC9164N	28Pin	M37470M2332S	32Pin	<p>BA6218</p> 	<p>M5F78M05L</p> 
TC74HC42AP	16Pin											
TC9163N	28Pin											
TC9164N	28Pin											
M37470M2332S	32Pin											
<p>2SA933QRSTA</p> 	<p>2SC3327-A</p> 	 <p>DTA124ESTP DTC114ESTP DTC114TSTP DTC114YSTP DTC144ESTP</p>	<p>RL1N4003N02</p> 	<p>MA165 MA167 MA29WA</p> 								
<p>1SS291TA</p> 	<p>MA4056MTA</p> 	<p>SLR-305DC SLR-305VC</p> 										

■ Wiring Connection Diagram

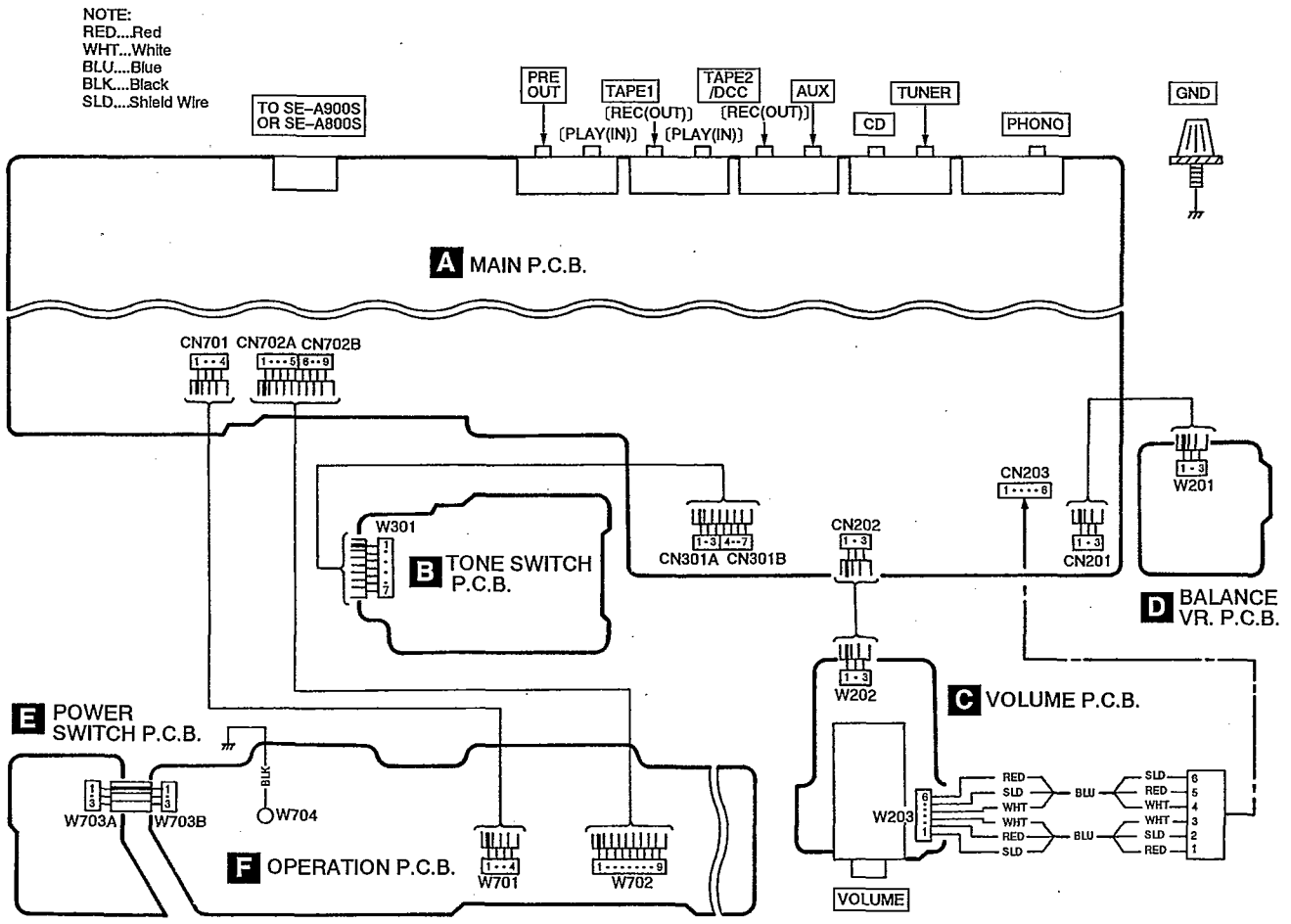

Block Diagram

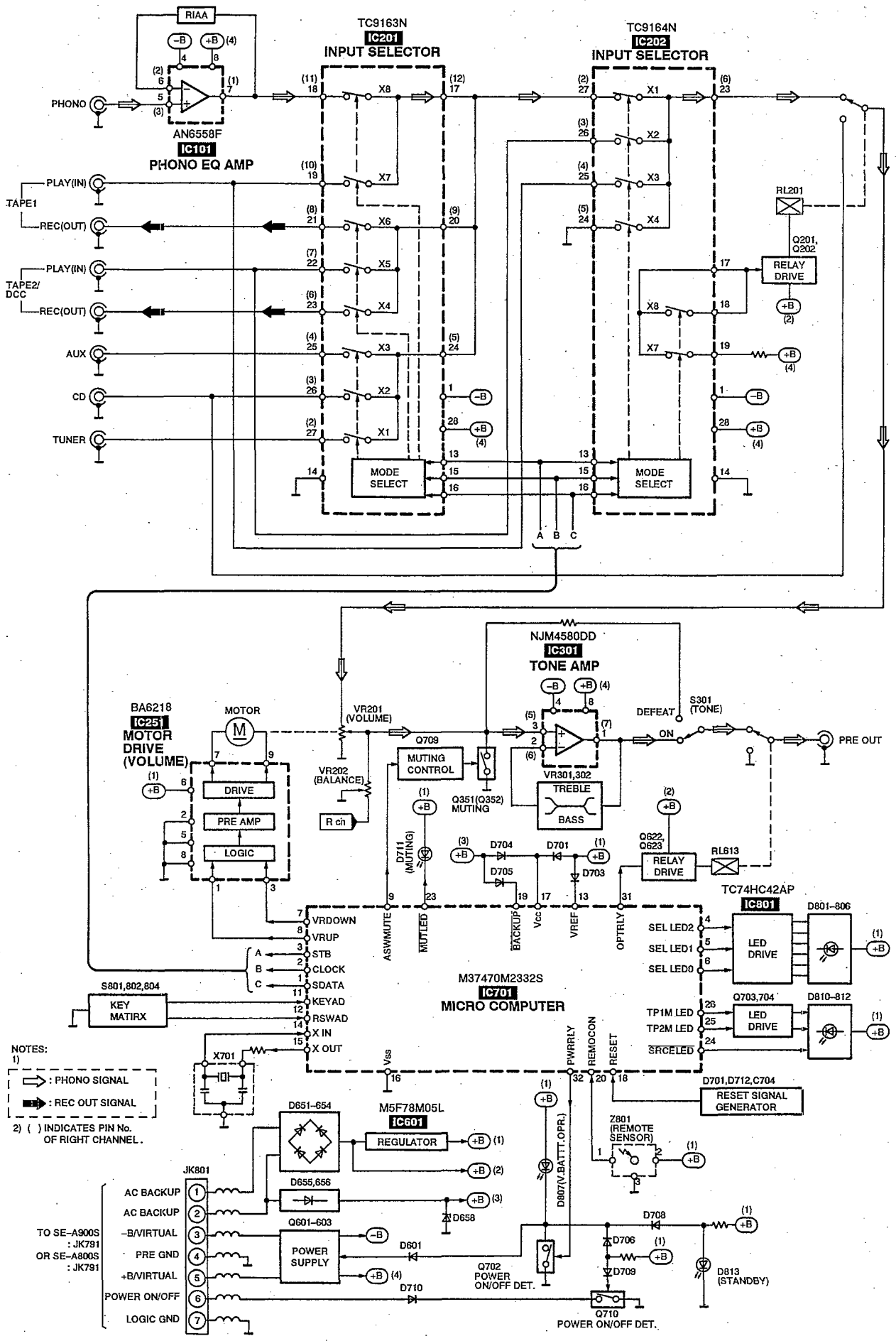

NOTES:
 1) : PHONO SIGNAL
 : REC OUT SIGNAL
 2) () INDICATES PIN No. OF RIGHT CHANNEL.

TO SE-A900S : JK791
 OR SE-A800S : JK791

Replacement Parts List

Notes: *Important safety notice:

 Components identified by Δ mark have special characteristics important for safety.

Furthermore, special parts which have purposes of fire-retardant (resistors), high-quality sound (capacitors), low-noise (resistors), etc. are used.

When replacing any of components, be sure to use only manufacturer's specified parts shown in the parts list.

*The parenthesized indications in the Remarks columns specify the areas. (Refer to the cover page for area.)

Parts without these indications can be used for all areas.

Ref. No.	Part No.	Part Name & Description	Remarks	Ref. No.	Part No.	Part Name & Description	Remarks
		INTEGRATED CIRCUIT(S)				VARIABLE RESISTOR(S)	
IC101	AN6558F	IC, PHONO EQ AMP.		VR201	EUWMGEF20B15	V. R, MAIN VOLUME	
IC201	TC9163N	IC, INPUT SELECTOR		VR202	EVJ02QF02G15	V. R, BALANCE	
IC202	TC9164N	IC, INPUT SELECTOR		VR301	EVJYA1F02C15	V. R, TONE CONTROL	
IC251	BA6218	IC, MOTOR DRIVE		VR302	EVJYA1F02C15	V. R, TONE CONTROL	
IC301	NJM4580DD	IC, TONE AMP.				COMPONENT COMBINATION(S)	
IC601	M5F78M05L	IC, REGULATOR	Δ				
IC701	M37470M2332S	IC, MICRO COMPUTER		Z801	RCDGP1U28XD	REMOTE SENSOR	
IC801	TC74HC42AP	IC, LED DRIVE				COIL(S)	
		TRANSISTOR(S)					
Q201	DTC114YSTP	TRANSISTOR		L251, 252	ELEXT1R0KA9	COIL	
Q202	DTA124ESTP	TRANSISTOR		L301-308	ELEXT100KA9	COIL	
Q351, 352	2SC3327-A	TRANSISTOR		L309	BL02RN1R62T2	COIL	
Q601, 602	DTA124ESTP	TRANSISTOR		L601-605	ELEXT1R0KA9	COIL	
Q603	DTC144ESTP	TRANSISTOR		L606, 607	ELEXT1R0KA9	COIL	Δ
Q622	DTC114YSTP	TRANSISTOR		L701	ELEXT101KA9	COIL	
Q623	DTA124ESTP	TRANSISTOR				OSCILLATOR(S)	
Q701	DTC114ESTP	TRANSISTOR					
Q702	DTC114TSTP	TRANSISTOR		X701	EF0GC4004A4	OSCILLATOR(4MHz)	
Q703, 704	DTC114YSTP	TRANSISTOR				SWITCH(ES)	
Q709	2SA933QRSTA	TRANSISTOR					
Q710	DTC114ESTP	TRANSISTOR		S301	ESB68047	SW, TONE (DEFEAT/ON)	
		DIODE(S)		S801	EVQ21405R	SW, POWER (STANDBY/ON)	
D201	MA165	DIODE		S802	EVQ21405R	SW, TAPE MONITOR	
D601	MA165	DIODE		S804	RSR9A001-A	SW, SELECTOR	
D621	MA165	DIODE				CONNECTOR(S)	
D651-654	RL1N4003N02	DIODE	Δ				
D655, 656	MA167	DIODE	Δ	CN201, 202	RJS1A6603	CONNECTOR(3P)	
D658	MA4056MTA	DIODE	Δ	CN203	SJT3611	CONNECTOR(6P)	
D701	1SS291TA	DIODE		CN301A	RJS1A6603	CONNECTOR(3P)	
D703	MA29WA	DIODE		CN301B	RJS1A6604	CONNECTOR(4P)	
D704	1SS291TA	DIODE		CN701	RJS1A6604	CONNECTOR(4P)	
D705, 706	MA165	DIODE		CN702A	RJS1A6605	CONNECTOR(5P)	
D708-710	MA165	DIODE		CN702B	RJS1A6604	CONNECTOR(4P)	
D711	SLR-305VC	L. E. D.		TP1-5	QJT1090	TEST POINT	
D712	MA165	DIODE				EARTH TERMINAL	
D801-807	SLR-305VC	L. E. D.					
D810	SLR-305VC	L. E. D.		E201, 202	SNE1004-2	GND PLATE	
D811, 812	SLR-305DC	L. E. D.					
D813	SLR-305VC	L. E. D.					

Ref. No.	Part No.	Part Name & Description	Remarks
E301	SNE1004-2	GND PLATE	
		RELAY	
RL201	RSY0020M-R	RELAY	
RL613	RSY0020M-R	RELAY	
		JACK	
JK201	SJF3069-11N	TERMINAL, PHONO	
JK202	SJF3069N	TERMINAL, TUNER/CD	
JK203	SJF3069N	TERMINAL, AUX/TAPE2/DCC	
JK204	SJF3069N	TERMINAL, TAPE2/DCC/TAPE1	
JK205	SJF3069N	TERMINAL, TAPE1/PRE OUT	
JK801	RJS1D0706	SOCKET, SYSTEM	

Ref. No.	Part No.	Part Name & Description	Remarks
		CABINET PARTS	
1	RKM0032-K	CABINET	
2	RHD30035-K1	SCREW	
3	XTBS3+8JFZ1	SCREW	
4	RGR0224A-A	REAR PANEL	
5	RGW0229-K	KNOB	
6	RGW0230-K	KNOB, VOLUME	
7	RKA0053-A	FOOT	
8	RKQ0089	P. C. B. SUPPORT	
9	FMK0035-6	CHASSIS	
10	RFKGUC800UEK	FRONT PANEL ASS' Y	
11	RGK0747-S	ORNAMENT RING	
12	RGL0296-Q	PANEL LIGHT (A)	
13	RGL0297-Q	PANEL LIGHT (B)	
14	RGL0298-Q	PANEL LIGHT (C)	
15	RGL0299-Q	PANEL LIGHT (D)	
16	RGU0882-K	BUTTON, POWER	
17	RGU1207-K	BUTTON, TONE	
18	RGU1271-K	BUTTON, MONITOR	
19	RGW0205-K	BUTTON, BALANCE	
20	RHD26017	SCREW	
21	RHN90001	NUT	
22	REX0759	FLAT CABLE	
23	RSC0428-1	SHIELD PLATE	
24	SNE2123	SCREW	
25	XTBS3+8JFZ1	SCREW	
26	XTB3+20JFZ	SCREW	
27	XTB3+6G	SCREW	
28	XTB3+6JFZ	SCREW	
29	RWJ1803040KK	FLAT CABLE (3P) (W703)	
30	RWJ3903170KQ	FLAT CABLE (3P) (W201)	
31	RWJ3907170KQ	FLAT CABLE (7P) (W301)	
32	RWJ3903140KQ	FLAT CABLE (3P) (W202)	
33	REU38K120XX	WIRE ASS' Y (W704)	
34	RWJ1809180KX	FLAT CABLE (9P) (W702)	
35	RWJ1804180KX	FLAT CABLE (4P) (W701)	

Cabinet Parts Location

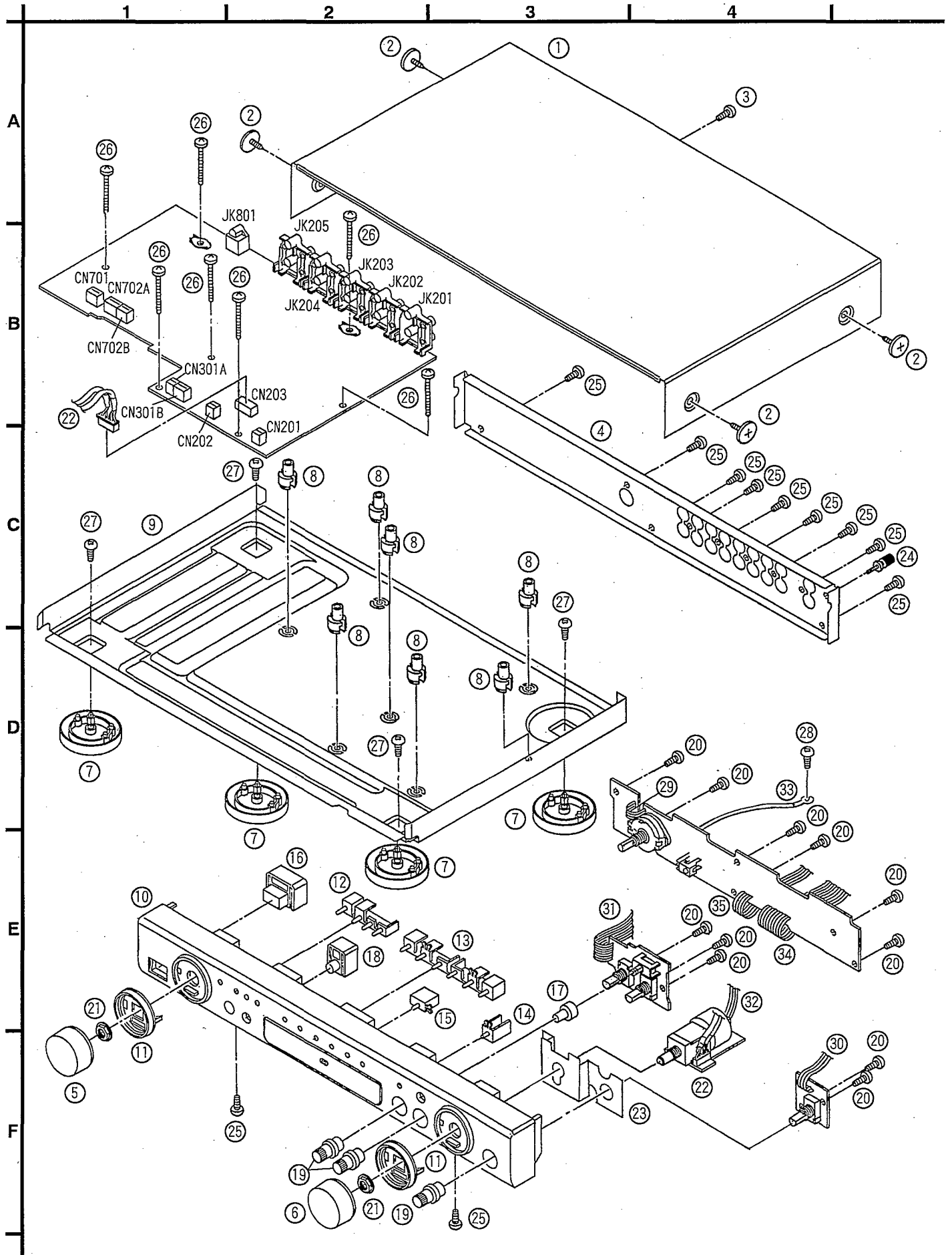

Notes : * Capacity values are in microfarads (uF) unless specified otherwise, P=Pico-farads (pF) F=Farads (F)
 * Resistance values are in ohms, unless specified otherwise, 1K=1,000(OHM) , 1M=1,000k(OHM)

Ref. No.	Part No.	Values & Remarks	Ref. No.	Part No.	Values & Remarks	Ref. No.	Part No.	Values & Remarks
		RESISTORS	R723-725	ERDS2TJ103	1/4W 10K	C305, 306	ECCR1H820JC5	50V 82P
			R726	ERDS2TJ102	1/4W 1K	C309, 310	ECA1HPXS010B	50V 1U
			R801	ERDS2TJ821	1/4W 820	C311, 312	ECCR1H390JC5	50V 39P
R101, 102	ERDS2TJ102	1/4W 1K	R802	ERDS2TJ102	1/4W 1K	C313, 314	ECA1EPX470TB	25V 47U
R103, 104	ERDS2TJ224T	1/4W 220K	R803	ERDS2TJ122	1/4W 1.2K	C315, 316	ECBTOJ153MS5	6.3V 0.015U
R105, 106	ERDS2TJ563	1/4W 56K	R804	ERDS2TJ152	1/4W 1.5K	C317, 318	ECQV1H823JM3	50V 0.082U
R117, 118	ERDS2TJ221	1/4W 220	R805	ERDS2TJ182	1/4W 1.8K	C319, 320	ECBT1C222KR5	16V 2200P
R123, 124	ERDS2TJ680T	1/4W 68	R806	ERDS2TJ222	1/4W 2.2K	C321, 322	ECBTOJ153MS5	6.3V 0.015U
R125, 126	ERDS2TJ123	1/4W 12K	R807	ERDS2TJ332	1/4W 3.3K	C323, 324	ECBT1H121KB5	50V 120P
R127, 128	ERDS2TJ184T	1/4W 180K	R808	ERDS2TJ472	1/4W 4.7K	C325	ECBT1H102KB5	50V 1000P
R129, 130	ERDS2TJ563	1/4W 56K	R809	ERDS2TJ682T	1/4W 6.8K	C327, 328	ECKT1H101KB	50V 100P
R131, 132	ERDS2TJ102	1/4W 1K	R810	ERDS2TJ123	1/4W 12K	C341, 342	ECBT1C332KR5	16V 3300P
R201-210	ERDAS3G102T	1/4W 1K	R811	ERDS2TJ223	1/4W 22K	C351, 352	ECKR1H103ZF5	50V 0.01U
R211, 212	ERDS2TJ102	1/4W 1K	R812	ERDS2TJ181T	1/4W 180	C601	ECEA1HKA010B	50V 1U
R213, 214	ERDAS3G102T	1/4W 1K	R813, 814	ERDS2TJ151	1/4W 150	C607, 608	ECA1EPXS470B	25V 47U
R215-217	ERDS2TJ103	1/4W 10K	R815	ERDS2TJ271	1/4W 270	C651	ECA1EM222E	25V 2200U
R219-221	ERDS2TJ103	1/4W 10K	R819	ERDS2TJ271	1/4W 270	C655	RCE1CKA470BG	16V 47U
R222, 223	ERDS2TJ102	1/4W 1K	R820	ERDS2TJ223	1/4W 22K	C656	ECQV1H104JM3	50V 0.1U
R224	ERDS2TJ472	1/4W 4.7K	R821	ERDS2TJ104	1/4W 100K	C657, 658	ECKR1H103ZF5	50V 0.01U
R225, 226	ERDAS3G222T	1/4W 2.2K	R822	ERDS2TJ271	1/4W 270	C701	ECA0JM102B	6.3V 1000U
R227, 228	ERDS2TJ104	1/4W 100K	R823-825	ERDS2TJ104	1/4W 100K	C702	ECBT1C103NS5	16V 0.01U
R251 Δ	ERDS1FVJ2R2T	1/2W 2.2				C703	RCE1HKAR47BG	50V 0.47U
R301, 302	ERDAS3G101T	1/4W 100			CAPACITORS	C704	ECEA1HKA2R2B	50V 2.2U
R303, 304	ERDS2TJ474	1/4W 470K				C705	ECBT1C103NS5	16V 0.01U
R305, 306	ERDAS3G104	1/4W 100K	C101, 102	ECBT1H181KB5	50V 180P	C706	ECQV1H224JM3	50V 0.22U
R315, 316	ERDS2TJ224T	1/4W 220K	C103, 104	ECA1HPXS4R7B	50V 4.7U	C707, 708	ECEA1HKA2R2B	50V 0.22U
R317, 318	ERDAS3G223T	1/4W 22K	C107, 108	RCE1AKA330BG	10V 33U	C709	ECBT1H102KB5	50V 1000P
R319, 320	ERDAS3G392T	1/4W 3.9K	C113, 114	ECQB1H682JF3	50V 6800P	C801	RCE0JKA101BV	6.3V 100U
R321, 322	ERDS2TJ223	1/4W 22K	C115, 116	ECQB1H223JF3	50V 0.022U			
R323, 324	ERDS2TJ392T	1/4W 3.9K	C117, 118	ECEA1VKA4R7B	35V 4.7U			
R325, 326	ERDS2TJ183T	1/4W 18K	C119, 120	ECQB1H472JF3	50V 4700P			
R327, 328	ERDS2TJ392T	1/4W 3.9K	C121, 122	ECKR1H103ZF5	50V 0.01U			
R329, 330	ERDS2TJ102	1/4W 1K	C123, 124	ECBT1H102KB5	50V 1000P			
R331, 332	ERDAS3G101T	1/4W 100	C201, 202	ECBT1H101KB5	50V 100P			
R333, 334	ERDAS3G221T	1/4W 220	C203, 204	ECKT1H101KB	50V 100P			
R353, 354	ERDS2TJ102	1/4W 1K	C205-208	ECBT1H101KB5	50V 100P			
R655	ERDS2TJ103	1/4W 10K	C209, 210	ECKT1H101KB	50V 100P			
R656 Δ	ERDS1FVJ100T	1/2W 10	C211, 212	ECBT1H101KB5	50V 100P			
R701	ERDS2TJ102	1/4W 1K	C213, 214	ECKT1H101KB	50V 100P			
R702, 703	ERDS2TJ103	1/4W 10K	C215	ECBT1H101KB5	50V 100P			
R704	ERDS2TJ104	1/4W 100K	C217, 218	ECBT1E103ZF	25V 0.01U			
R706	ERDS2TJ103	1/4W 10K	C219, 220	RCE1HKA4R7BG	50V 4.7U			
R707-709	ERDS2TJ104	1/4W 100K	C221	ECBT1H101KB5	50V 100P			
R710-712	ERDS2TJ103	1/4W 10K	C223, 224	RCE1HKA4R7BG	50V 4.7U			
R713	ERDS2TJ102	1/4W 1K	C225, 226	ECBT1E103ZF	25V 0.01U			
R714	ERDS2TJ331	1/4W 330	C251, 252	RCE0JKA101BV	6.3V 100U			
R715, 716	ERDS2TJ273	1/4W 27K	C253, 254	ECQV1H104JM3	50V 0.1U			
R717	ERDS2TJ334	1/4W 330K	C301, 302	ECA1HPXS4R7B	50V 4.7U			
R718-721	ERDS2TJ473	1/4W 47K	C303, 304	ECCR1H470JC5	50V 47P			

992